

## PRODUCT DATASHEET

### OUTDOOR LIGHTING | OUTDOOR FLOODLIGHTS

Outdoor lighting | Floodlight | IP65 | 9W

Code# OTFL18004-9



#### Areas of Application

- Building silhouettes
- Stadiums
- Overpasses
- Monuments
- Parks
- Flowerbeds

#### Product Features

- IP65 water-proof rating
- The floodlight can be rotated to adjust the angle
- Configured with CREE/OSRAM/PHILIPS original high-power light source, with excellent light color performance, temperature resistance, high light transmission, flame retardant optics
- With lens built-in technology to minimize glare, stray light, optional honeycomb anti-glare
- CREE / OSRAM / Epistar Brand LED chip, high efficiency lumen, 5° /10° /15° /25° /45° /60° /90° beam angle.

---

## Complete Product Data

<b>Code#</b>	OTFL18004-9
<b>Wattage</b>	9W
<b>Installation Type</b>	Pole-Mounted/Wall or ground installation
<b>Dimension</b>	95*95*115
<b>LED Numbers</b>	6
<b>IP Rating</b>	IP65
<b>Luminous Flux</b>	720lm
<b>Beam Angle</b>	5° /10° /15° /25° /45° /60° /90°
<b>Working Temperature</b>	-25°C ~55°C
<b>Certificates</b>	/
<b>Warranty</b>	3 Years
<b>Packing Size</b>	/

## Driver Data

<b>Driver Brand</b>	Tridonic, Osram, Philips, Lifud, Euchips, Eaglerise, etc.
<b>Input Voltage</b>	100-250VAC 50/60hz
<b>Output Voltage</b>	DC24V
<b>Output Current</b>	Constant current
<b>Power Factor</b>	>0.5 as standard; >0.9 optional
<b>Efficiently</b>	87% @230v
<b>IP Rating</b>	IP20
<b>Dimmable</b>	Non-Dimmable/Triac/0-10v/Dali Optional
<b>Free Flicker</b>	Yes
<b>Certificates</b>	CE, CB, CCC, ENEC
<b>Warranty</b>	3/5 Years

## Material&Housing Data

<b>Light Body Color</b>	Grey/ Balck
<b>Reflector Color</b>	/
<b>Light Body Material</b>	Die-casting Aluminum

## Photometric Data

<b>LED chip brand</b>	Cree/ Osram /Bridgelux/ Epistar etc.
<b>Chip Type</b>	COB
<b>Color Temperature</b>	2700K, 3000K, 4000K, 6000K
<b>CRI</b>	>80
<b>Life time</b>	>50000Hrs
<b>Lumens efficacy</b>	/

---

## Dimensions&Installation

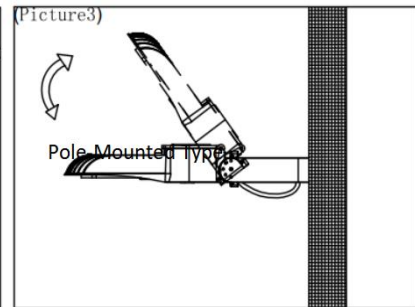
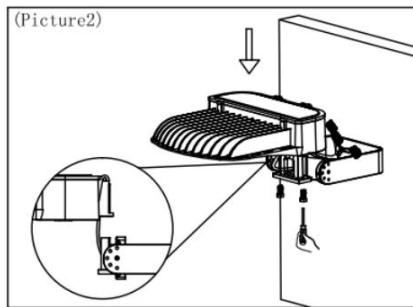
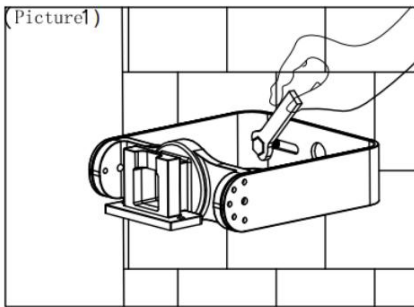
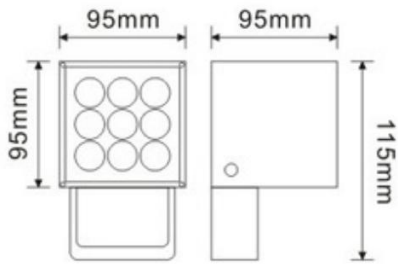

1. Fix the bracket on the wall and tighten the screw. (as shown in the picture)
2. The floodlight is mounted on the bracket adapter, and tighten two fastening screws at the bottom of the bracket adapter, and then connect the power supply AC line of the arm adaptor according to the requirements.
3. According to the use environment, customers can adjust the rotation angle of lights