

PRODUCT DATASHEET

OUTDOOR LIGHTING | OUTDOOR FLOODLIGHTS

Outdoor lighting | Floodlight | IP65 | 36W

Code# OTFL18002-36



Areas of Application

- Building silhouettes
- Stadiums
- Overpasses
- Monuments
- Parks
- Flowerbeds

Product Features

- IP65 water-proof rating
- The floodlight can be rotated to adjust the angle
- Configured with CREE/OSRAM/PHILIPS original high-power light source, with excellent light color performance, temperature resistance, high light transmission, flame retardant optics
- With lens built-in technology to minimize glare, stray light, optional honeycomb anti-glare
- CREE / OSRAM / Epistar Brand LED chip, high efficiency lumen, 5° /10° /15° /25° /45° /60° /90° beam angle.

Complete Product Data

Code#	OTFL18002-36
Wattage	36W
Installation Type	Pole-Mounted/Wall or ground installation
Dimension	200*200*250
LED Numbers	36
IP Rating	IP65
Luminous Flux	2880lm
Beam Angle	5° /10° /15° /25° /45° /60° /90°
Working Temperature	-25°C ~55°C
Certificates	/
Warranty	3 Years
Packing Size	/

Driver Data

Driver Brand	Tridonic, Osram, Philips, Lifud, Euchips, Eaglerise, etc.
Input Voltage	100-250VAC 50/60hz
Output Voltage	DC24V
Output Current	Constant current
Power Factor	>0.5 as standard; >0.9 optional
Efficiently	87% @230v
IP Rating	IP20
Dimmable	Non-Dimmable/Triac/0-10v/Dali Optional
Free Flicker	Yes
Certificates	CE, CB, CCC, ENEC
Warranty	3/5 Years

Material&Housing Data

Light Body Color	Black
Reflector Color	/
Light Body Material	Die-casting Aluminum

Photometric Data

LED chip brand	Cree/ Osram /Bridgelux/ Epistar etc.
Chip Type	COB
Color Temperature	2700K, 3000K, 4000K, 6000K
CRI	>80
Life time	>50000Hrs
Lumens efficacy	/

Dimensions&Installation

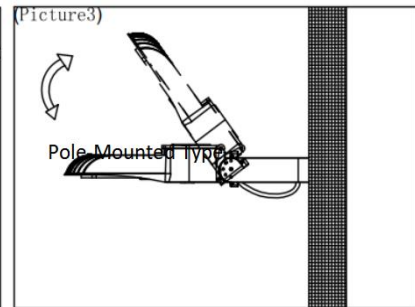
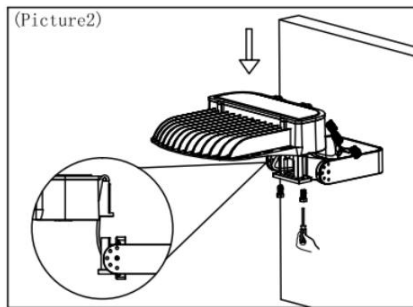
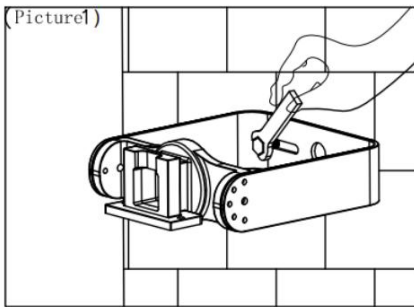
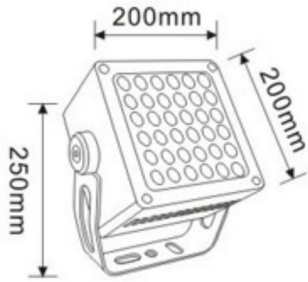

1. Fix the bracket on the wall and tighten the screw. (as shown in the picture)
2. The floodlight is mounted on the bracket adapter, and tighten two fastening screws at the bottom of the bracket adapter, and then connect the power supply AC line of the arm adaptor according to the requirements.
3. According to the use environment, customers can adjust the rotation angle of lights