

PRODUCT DATASHEET

OUTDOOR LIGHTING | BOLLARDS

Garden Light | Pathway Light | Led Bollards | 12w | Round shape | IP65 | Anti-Glare
Code# BL19005-80



Areas of Application

- Villa garden
- Park
- Scenic spot
- Communities

Product Features

- High quality aluminum housing, ensure excellent heat dissipation
- IP65 waterproof
- Creative cross shaped illumination provides better decorative effects
- CCT optional
- Customized height is available
- 3 years warranty

Complete Product Data

Code#	BL19005-80
Wattage	12w
Installation Type	Floor mounted
Dimension	Φ 180*H800
Cutout	/
IP Rating	IP65
Luminous Flux	600lm
Beam Angle	/
Working Temperature	-25°C~55°C
Certificates	/
Warranty	3 Years
Packing Size	/

Driver Data

Driver Brand	DONE, Meanwell or customized
Input Voltage	200-240VAC 50/60hz
Output Voltage	30-42Vdc
Output Current	300mA
Power Factor	>0.9 optional
Efficiently	83% @230v
IP Rating	IP65
Dimmable	Non-Dimmable/Triac/0-10v/Dali Optional
Free Flicker	Yes
Certificates	CE, CB, CCC, ENEC
Warranty	3/5 Years

Material&Housing Data

Housing Color	Gray/ Black
Housing Material	Die-casting aluminum +Aluminum
Reflector Color	/

Photometric Data

LED chip brand	Epistar
Chip Type	COB
Color Temperature	2700K, 3000K, 4000K, 5000K, 6000K, 6500K 
CRI	>80
Life time	>50000Hrs
Lumens efficacy	80-120lm/w

Dimensions&Installation

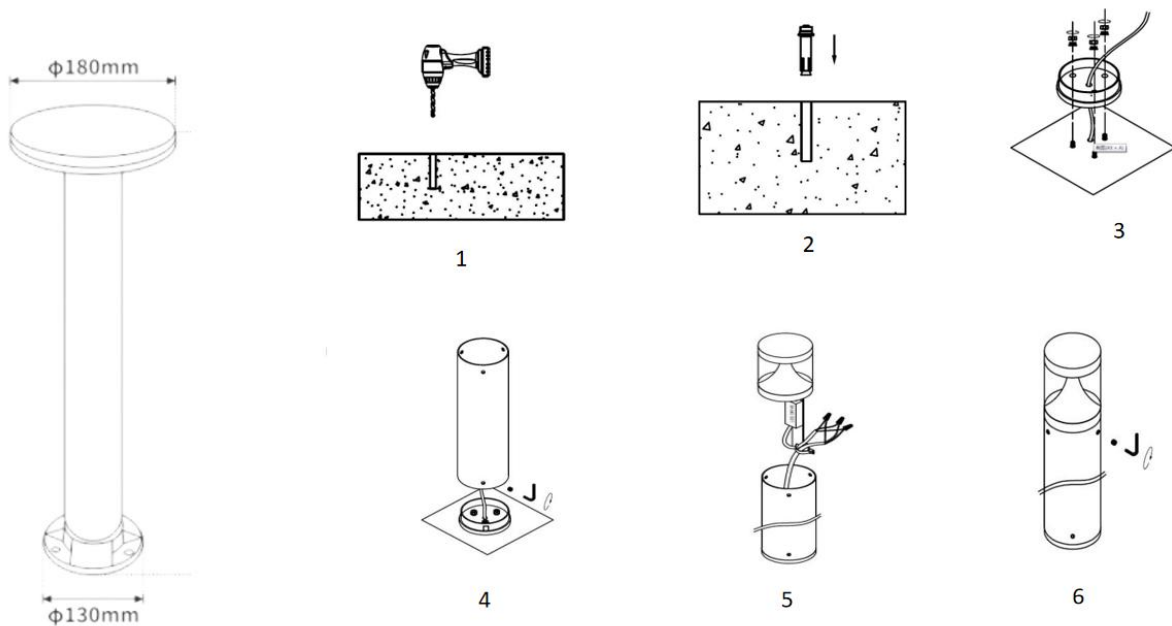

PLEASE FIND A QUALIFIED ELECTRICIAN FOR INSTALLATION. Please read the instructions before you install and use the led bollard light.

1. Make sure the power is turned off in which you are installing the products.
2. Before wiring , make certain the input voltage is correct.
3. Drill holes in the cement foundation same same as Fig 1.
4. Place expansion screws in the drilled holes same as fig 2.
5. Lock the bottom of the lamp onto the expansion screws same as fig 3.
6. Lock the aluminum body onto the base same as fig 4.
7. Connect the wire of the lamp, wrap the waterproof tape, and tie the wire in the driver support same as fig 5.
8. Install the lamp holder and the screw it tight(it if it E27 type), check the lamp is firm after installation, and connect the power supply to light it.

Cleaning & Maintenance

1. Be sure fixture temperature is cool enough to touch, do not clean or maintain while fixture is energized.
2. Clean lens & fixture with non-abrasive glass cleaning solution.
3. Do not open the fixture to clean the LED, do not touch the led.