

PRODUCT DATASHEET

LINEAR LIGHT | PENDANT LINEAR

Linear light |Pendant mounted linear light 24w|Square shape
Code# LP044265-90



Areas of Application

- Gym
- Library
- Office
- Club
- Shops
- Living room, restaurant, residential interiors

Product Features

- High luminous efficacy, high CRI
- Energy savings of up to 90% compared to halogen lamp spotlights
- CCT optional and dimmable
- Die-cast aluminum housing, ensure excellent heat dissipation
- Uniform light output and good consistency
- Anti-Glare, without flicker
- Easy and quick installation

Complete Product Data

Code#	LP044265-90
Wattage	24w
Installation Type	Suspended
Dimension	L900mm*W42mm*H65mm
Cutout	/
IP Rating	IP20
Luminous Flux	2160lm
Beam Angle	110°
Working Temperature	-25°C ~55°C
Certificates	/
Warranty	3 Years
Packing Size	/

Driver Data

Driver Brand	Tridonic, Osram, Philips, Lifud, Euchips, Eaglerise, etc.
Input Voltage	100-250VAC 50/60hz
Output Voltage	27-39Vdc
Output Current	600mA
Power Factor	>0.5 as standard; >0.9 optional
Efficiently	87% @230v
IP Rating	IP20
Dimmable	Non-Dimmable/Triac/0-10v/Dali Optional
Free Flicker	Yes
Certificates	CE, CB, CCC, ENEC
Warranty	3/5 Years

Material&Housing Data

Housing Color	White/ Black
Reflector Color	/
Housing Material	Aluminum

Photometric Data

LED chip brand	Cree/ Osram /Bridgelux/ Epistar etc.
Chip Type	SMD
Color Temperature	2700K, 3000K, 4000K, 5000K, 6000K
CRI	>82
Life time	>50000Hrs
Lumens efficacy	100-120lm/w

Dimensions&Installation

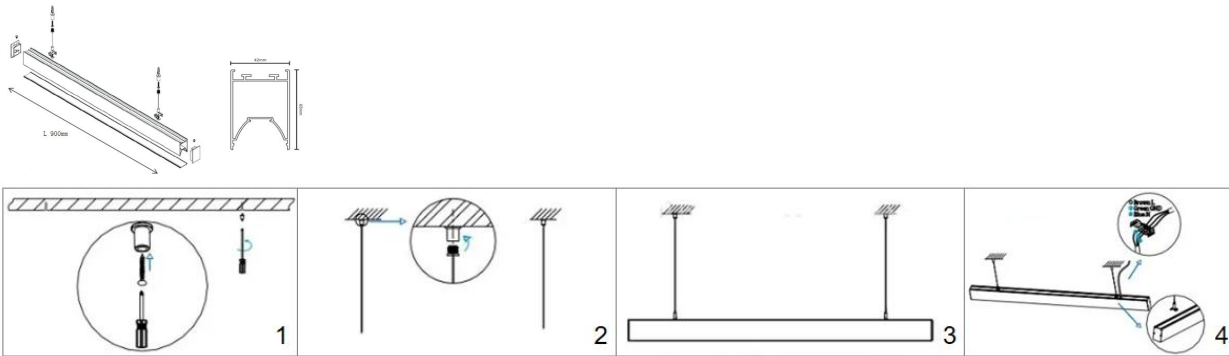

PLEASE FIND A QUALIFIED ELECTRICIAN FOR INSTALLATION. Please read the instructions before you install and use the downlight.

1. Make sure the power is turned off in which you are installing the products.
2. Drill holes in the right place on the ceiling. (Fig 1)
3. Fix the accessories on the ceiling and install the sling. (Fig 2)
4. Adjust the length of the line according to actual needs. (Fig 3)
5. Connect the power cord through the junction box. (Fig 4)
6. Restore power at the source and the installation is complete.