

PRODUCT DATASHEET

DOWNLIGHTS | TRACKLIGHTS-NORMAL TRACK

Downlights | Surface mounted spotlight 30w | Round shape | Zoomable
Code# TK05006-30



Areas of Application

- Shops
- Villa
- Hotel
- Club
- Corridors, stairways, entrance areas
- Galleries, museums residential interiors

Product Features

- High luminous efficacy, high CRI
- Lamp can be adjusted the irradiation direction for precise lighting
- Energy savings of up to 90% compared to halogen lamp spotlights
- CCT optional and dimmable
- Die-cast aluminum housing, ensure excellent heat dissipation
- Uniform light output and good consistency, without flicker
- Easy and quick installation
- Stepless beam angle adjustable from 15° to 60°
- 90° adjustable in vertical
- Rotatable through 355° on adapter

Complete Product Data

Code#	TK05006-30
Wattage	30w
Installation Type	Surface
Dimension	φ68mm*160mm
Cutout	/
IP Rating	IP20
Luminous Flux	2400lm
Beam Angle	15°~60°
Working Temperature	-25°C ~55°C
Certificates	/
Warranty	3 Years
Packing Size	/

Driver Data

Driver Brand	Tridonic, Osram, Philips, Lifud, Euchips, Eaglerise, etc.
Input Voltage	100-250VAC 50/60hz
Output Voltage	24-42Vdc
Output Current	750mA
Power Factor	>0.5 as standard; >0.9 optional
Efficiently	87% @230v
IP Rating	IP20
Dimmable	Non-Dimmable/Triac/0-10v/Dali Optional
Free Flicker	Yes
Certificates	CE, CB, CCC, ENEC
Warranty	3/5 Years

Material&Housing Data

Housing Color	Black / White
Reflector Color	Black / White
Housing Material	Aluminum

Photometric Data

LED chip brand	Cree/ Osram /Bridgelux/ Epistar etc.
Chip Type	COB
Color Temperature	2700K, 3000K, 4000K, 5000K, 6000K
CRI	>90
Life time	>50000Hrs
Lumens efficacy	100-120lm/w

Dimensions&Installation

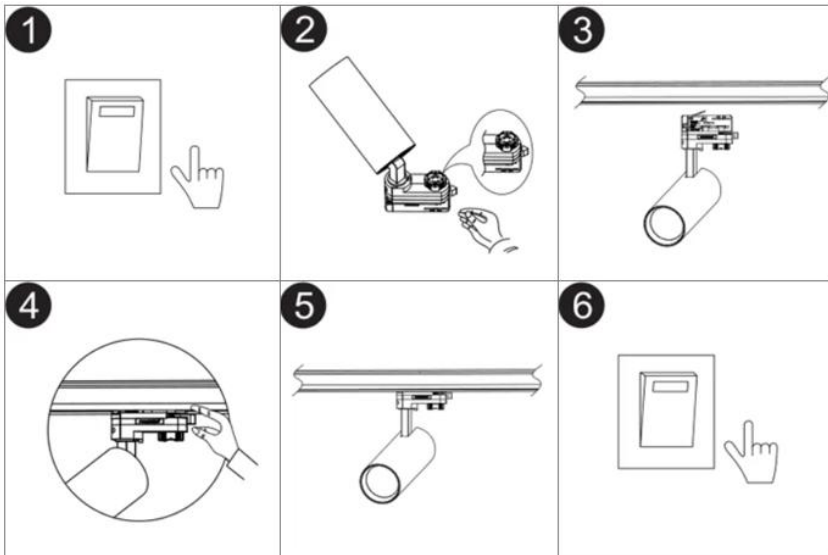

PLEASE FIND A QUALIFIED ELECTRICIAN FOR INSTALLATION. Please read the instructions before you install and use the downlight.

1. Make sure the power is turned off in which you are installing the products. (Fig 1)
2. Set the power adapter to off. (Fig 2)
3. Put the track light into the track bar. (Fig 3)
4. Slide the adapter switch to ensure the adapter is locked in the track bar. (Fig 4)
5. Adjust the lighting angle and direction. (Fig 5)
6. Restore power at the source and the installation is complete. (Fig 6)